

# MICO CUT UÇLARI ve TAKIMLAR

MICO CUT INSERT and TOOLS

MICO CUT WENDESCHIEDPLATTEN WERKZEUGE

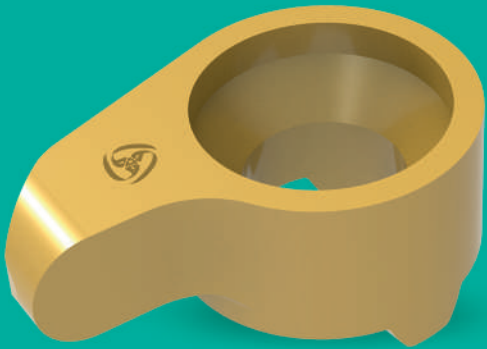
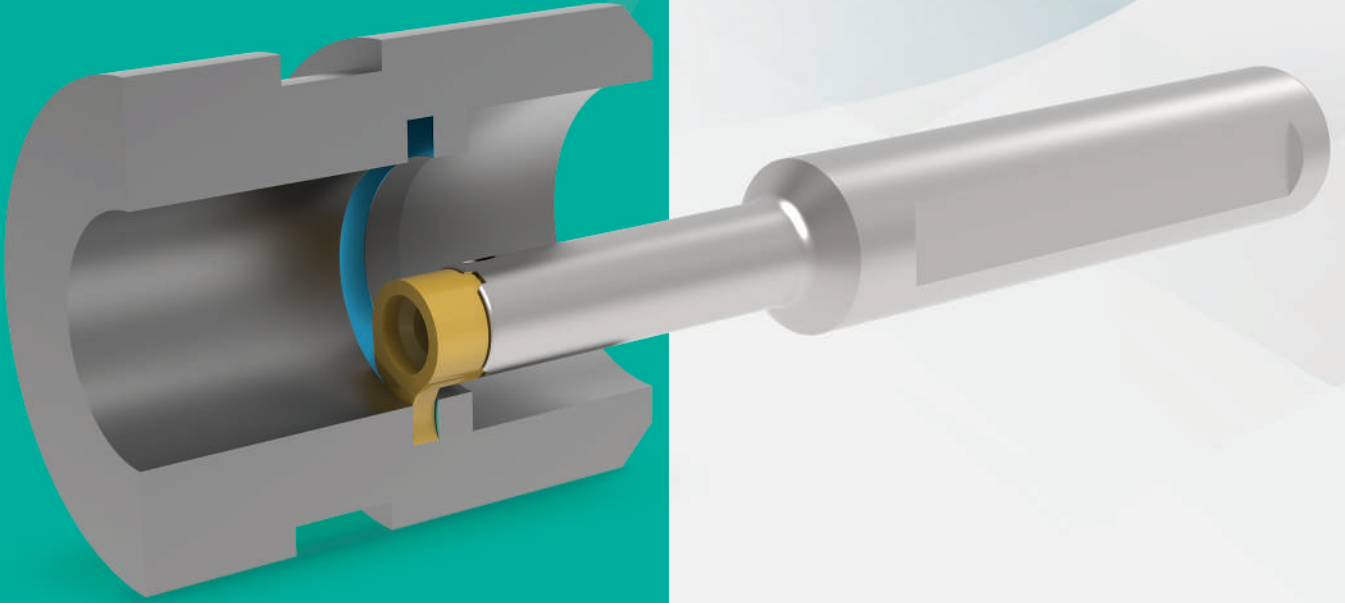

[www.vavkesici.com.tr](http://www.vavkesici.com.tr)

Yenilikler için bizi takip edin.  
Follow us for news.  
Für Neuheiten bitte uns folgen.

**2025'te Stoklarda**

**It will be available  
at our stocks in 2025**

*Es wird im Jahr 2025  
im Lager verfügbar sein*

ÇELİK ŞAFT  
STEEL SHAFT  
STAHSCHÄFTE

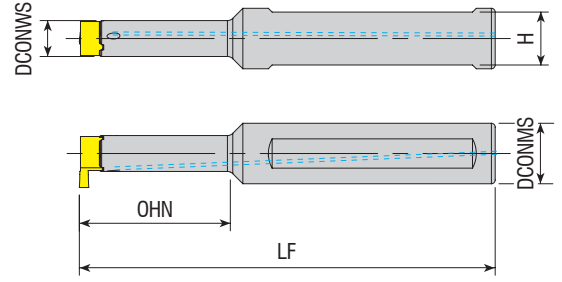

Takım Kodu Ordering Code Bestell-Bezeichnung	Stok Stock Lager	Takım Ölçüleri (mm) Dimension (mm) Abmessung (mm)					Kesici Uç Insert Wendeschneidplatte	Yedek Parçaları / Spare Parts / Ersatzteile	
		DCONMS	DCONWS	LF	OHN	H		Sıkma Vidası Screw Klemmschraube	Tork Anahtar Torx Key Torx Innensechskantschlüssel
A12G-MC08-015	○	12	8	90	15	11	MC08	4015xM4X11	80-T15
A12G-MC08-022	○	12	8	90	22	11			
A12G-MC11-019	○	12	11	90	19	15	MC11	T20-M5X14	80-T20
A16G-MC11-028	○	16	11	100	28	15			
A16J-MC11-040	○	16	11	110	40	15			

KARBÜR ŞAFT  
CARBIDE SHAFT  
HARTMETALLSCHAFT

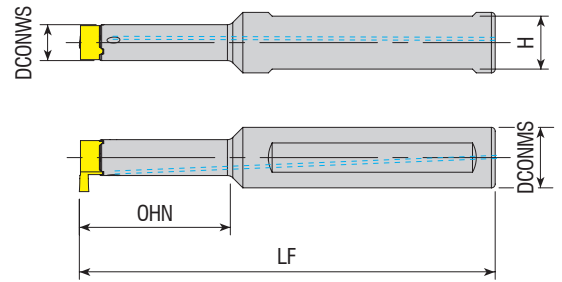

Takım Kodu Ordering Code Bestell-Bezeichnung	Stok Stock Lager	Takım Ölçüleri (mm) Dimension (mm) Abmessung (mm)					Kesici Uç Insert Wendeschneidplatte	Yedek Parçaları / Spare Parts / Ersatzteile	
		DCONMS	DCONWS	LF	OHN	H		Sıkma Vidası Screw Klemmschraube	Tork Anahtar Torx Key Torx Innensechskantschlüssel
E12J-MC08-042	○	12	8	110	42	11	MC08	4015xM4X11	80-T15
E12K-MC08-056	○	12	8	120	56	11			
E12J-MC11-040	○	12	11	130	40	15	MC11	T20-M5X14	80-T20
E16K-MC11-056	○	16	11	130	56	15			
E16K-MC11-080	○	16	11	150	80	15			

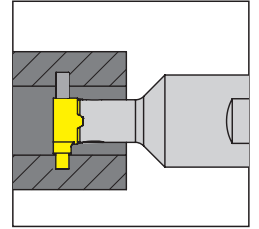
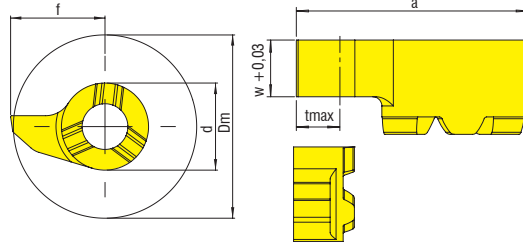
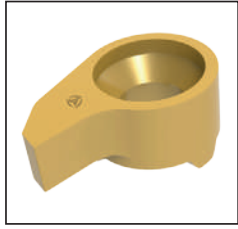

Uç Kodu Insert Code Wendepplatten-Bezeichnung	Stok Stock Lager	Uç Ölçüleri (mm) Insert Dimension (mm) Abmessung (mm)							UYUMLU TAKIM / COMPATIBLE TOOLHOLDER / KOMPATIBLES WERKZEUG	Kalite Grade Sorte
		W	R	a	d	f	tmax	Dm		
MC08.G.0100.010.01340	○	1.0	0.10	10.7	8.0	6.7	2.3	13.4	....-MC08-0..	VP3001
MC08.G.0150.015.01340	○	1.5	0.15	10.7	8.0	6.7	2.3	13.4		VP3001
MC08.G.0200.020.01340	○	2.0	0.20	10.7	8.0	6.7	2.3	13.4		VP3001
MC08.G.0250.025.01340	○	2.5	0.25	10.7	8.0	6.7	2.3	13.4		VP3001
MC08.G.0300.030.01340	○	3.0	0.30	10.7	8.0	6.7	2.3	13.4		VP3001

### DIĞER PROFİL ÇEŞİTLERİ / THE OTHERS PROFILE TYPES / ANDERE PROFIL-TYPEN

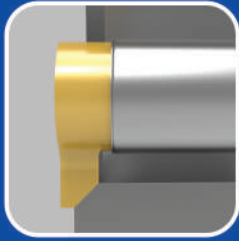

CHAMFER PROFILE

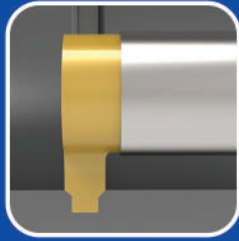

CIRCLIP PROFILE



THREAD PROFILE

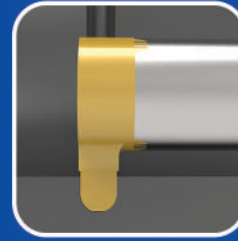

RADIUS GROVE PROFILE

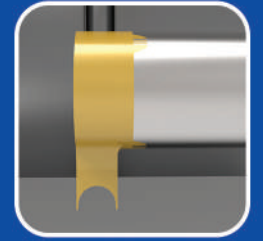

SPECIAL PROFILE

\*Diğer profil uçlar özel taleplere göre üretilmektedir. / Profiled inserts are manufactured according to customer special requirements. /  
Die Profil-Wendeschneidplatten werden nach Kundenwunsch gefertigt.

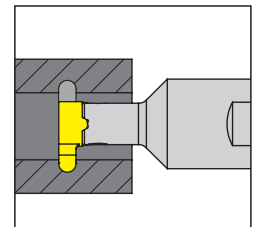
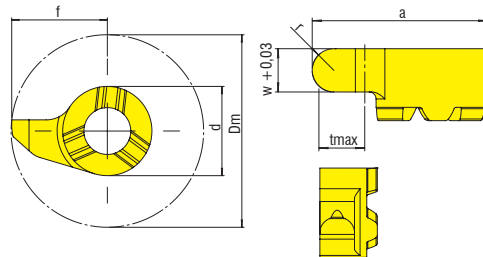

Uç Kodu Insert Code Wendepplatten-Bezeichnung	Stok Stock Lager	Uç Ölçüleri (mm) Insert Dimension (mm) Abmessung (mm)							UYUMLU TAKIM / COMPATIBLE TOOLHOLDER / KOMPATIBLES WERKZEUG	Kalite Grade Sorte
		W	R	a	d	f	tmax	Dm		
MC08.GR.0080.040.01340	○	0.8	0.4	10.7	8	6.7	2.3	13.4	....-MC08-0..	VP3001
MC08.GR.0120.060.01340	○	1.2	0.6	10.7	8	6.7	2.3	13.4		VP3001
MC08.GR.0180.090.01340	○	1.8	0.9	10.7	8	6.7	2.3	13.4		VP3001
MC08.GR.0200.100.01340	○	2.0	1.0	10.7	8	6.7	2.3	13.4		VP3001
MC08.GR.0300.150.01340	○	3.0	1.5	10.7	8	6.7	2.3	13.4		VP3001

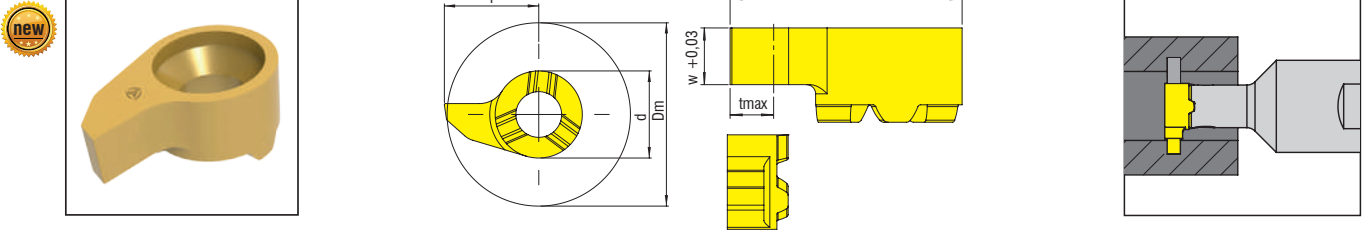

Uç Kodu Insert Code Wendepplatten-Bezeichnung	Stok Stock Lager	Uç Ölçüleri (mm) Insert Dimension (mm) Abmessung (mm)							UYUMLU TAKIM / COMPATIBLE TOOLHOLDER / KOMPATIBLES WERKZEUG	Kalite Grade Sorte
		W	R	a	d	f	tmax	Dm		
MC11.G.0100.010.02040	○	1.0	0.1	15.7	11	10.2	4.3	20.4	....-MC11-0..	VP3001
MC11.G.0150.015.02040	○	1.5	0.15	15.7	11	10.2	4.3	20.4		VP3001
MC11.G.0200.020.02040	○	2.0	0.2	15.7	11	10.2	4.3	20.4		VP3001
MC11.G.0250.025.02040	○	2.5	0.25	15.7	11	10.2	4.3	20.4		VP3001
MC11.G.0300.030.02040	○	3.0	0.3	15.7	11	10.2	4.3	20.4		VP3001
MC11.G.0350.035.02040	○	3.5	0.35	15.7	11	10.2	4.3	20.4		VP3001
MC11.G.0400.040.02040	○	4.0	0.40	15.7	11	10.2	4.3	20.4		VP3001

### DIĞER PROFİL ÇEŞİTLERİ / THE OTHERS PROFILE TYPES / ANDERE PROFIL-TYPEN

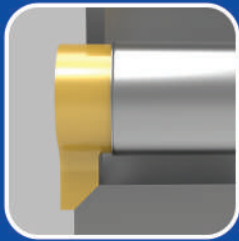

CHAMFER PROFILE

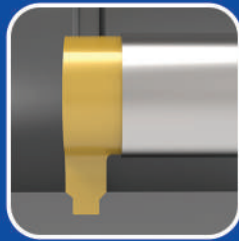

CIRCLIP PROFILE



THREAD PROFILE

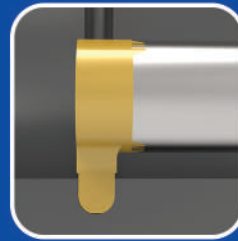

RADIUS GROVE PROFILE

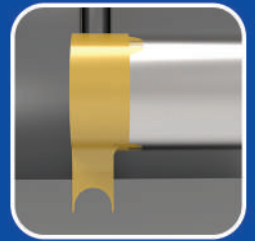

SPECIAL PROFILE

\*Diğer profil uçlar özel taleplere göre üretilmektedir. / Profiled inserts are manufactured according to customer special requirements. /  
Die Profil-Wendeschneidplatten werden nach Kundenwunsch gefertigt.

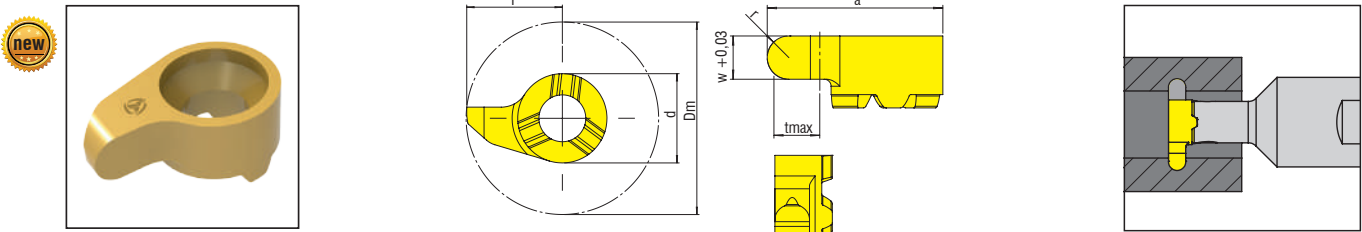

Uç Kodu Insert Code Wendepplatten-Bezeichnung	Stok Stock Lager	Uç Ölçüleri (mm) Insert Dimension (mm) Abmessung (mm)							UYUMLU TAKIM / COMPATIBLE TOOLHOLDER / KOMPATIBLES WERKZEUG	Kalite Grade Sorte
		W	R	a	d	f	tmax	Dm		
MC11.GR.0180.090.02040	○	1.8	0.9	15.7	11.0	10.2	4.3	20.4	....-MC11-0..	VP3001
MC11.GR.0220.110.02040	○	2.2	1.1	15.7	11.0	10.2	4.3	20.4		VP3001
MC11.GR.0300.150.02040	○	3.0	1.5	15.7	11.0	10.2	4.3	20.4		VP3001
MC11.GR.0400.200.02040	○	4.0	2.0	15.7	11.0	10.2	4.3	20.4		VP3001